



ACROBAT 2" LED DOWNLIGHT SHALLOW PLENUM

PROJECT: _____

TYPE: _____

NOTE: _____

SPEC-00275 ACROBAT 2.0, 2" SP, V-1.3, UPDATED 10/14/2022

A2-SIC, A2-SNC



ACROBAT PERFORMANCE AND PRECISION

A2-S - Shallow Plenum

Up to 1855 Delivered Lumens

Multiple Dimming Drivers Available

LED LIGHT ENGINE

RATED WATTAGE	10W, 15W, 20W
DELIVERED LUMENS	Up to 1855 lm @ 4000K-20W-30°Optic
EFFICACY	Up to 96.2 LPW @ 4000K-10W-30°Optic
CCT @ 90CRI	2700K, 3000K, 3500K, 4000K, Warm Dim
COLOR QUALITY	90+ CRI, 2-Step SDCM
LED LIFETIME	55,000 hours @ L90

DELIVERED LUMENS MATRIX

		10° Optic	30° Optic	50° Optic	80° Optic
10 Watt	2700K (90CRI)	848 lm	912 lm	874 lm	739 lm
	3000K (90CRI)	900 lm	968 lm	927 lm	785 lm
	3500K (90CRI)	943 lm	1014 lm	972 lm	822 lm
	4000K (90CRI)	978 lm	1052 lm	1008 lm	853 lm
	Warm Dim	572 lm	627 lm	587 lm	460 lm
15 Watt	2700K (90CRI)	1235 lm	1329 lm	1273 lm	1078 lm
	3000K (90CRI)	1311 lm	1410 lm	1351 lm	1144 lm
	3500K (90CRI)	1374 lm	1478 lm	1417 lm	1199 lm
	4000K (90CRI)	1425 lm	1533 lm	1469 lm	1243 lm
	Warm Dim	877 lm	961 lm	899 lm	705 lm
20 Watt	2700K (90CRI)	1495 lm	1608 lm	1541 lm	1304 lm
	3000K (90CRI)	1587 lm	1706 lm	1635 lm	1384 lm
	3500K (90CRI)	1663 lm	1789 lm	1714 lm	1451 lm
	4000K (90CRI)	1725 lm	1855 lm	1778 lm	1504 lm
	Warm Dim	1059 lm	1161 lm	1086 lm	852 lm

SILENT VU™ OPTICS TECHNOLOGY

OPTICS	10°, 30°, 50°, 80° available
MEDIA	Clear, Solite, Frosted, Linear Spread, Hex Louver

POWER SUPPLY

INPUT VOLTAGE	120-277V, 50/60Hz
DIMMING	Multiple dimming drivers available
SERVICEABILITY	Below Ceiling Access

TRIM OPTIONS

- Round or Square
- Standard or Trimless
- Pinhole, Slot Pinhole
- Wall Wash
- Wet Location

TRIM COLORS

- White
- Black
- Custom Color
- Champagne
- Satin Aluminum

REFLECTOR COLORS

- White
- Black
- Clear Alzak
- Champagne
- Satin Aluminum
- Custom Color

HOUSING INSTALLATION

- New Construction includes (2) galvanized steel adjustable hanger bars
- 5/8" – 2" ceiling thickness
- Min Plenum Height: 2½" Shallow
- Ceiling Material: Drywall, T-bar grid, Wood and Millwork
- Steel junction box with up to (6) ½" knockouts
- SIC models are Air Tight
- SIC models are CCEA (Chicago Plenum)
(Note: polycell spray-in foam insulation must be kept 3" from housing)

LISTINGS AND WARRANTY

cULus Listed for 40°C Ambient	ASTM E283 Certified Airtight for IC Rated Housings
UL Listed for Damp Location	UL Listed for Wet Location (Wet Location Trim Style)
IC Rated and Non IC Rated Available	CCEA (Chicago Plenum) Approved for IC Rated Housings
Five (5) years limited warranty	CA Title 24-JA8 Compliant





ACROBAT 2" LED DOWNLIGHT SHALLOW PLENUM

PROJECT: _____

TYPE: _____

NOTE: _____

SPEC-00275 ACROBAT 2.0, 2" SP, V-1.3, UPDATED 10/14/2022

A2-SIC, A2-SNC

ORDER MATRIX

A2-SIC, A2-SNC

2" SHALLOW PLENUM NEW CONSTRUCTION HOUSING (EXAMPLE: A2-SIC-RST-02790-30-10S-SHB)

HOUSING BASE					
FAMILY APERTURE	INSTALLATION TYPE		TRIM SHAPE	TRIM STYLE	
A2- Acrobat 2"	SIC (Shallow Plenum New Construction, IC, CCEA)		-R (Round)	ST (Standard)	
	SNC (Shallow Plenum New Construction)		-S (Square)	TL (Trimless) WC (Wood Ceiling)	
CEILING		LED PERFORMANCE		OPTIC AND MEDIA	
CEILING THICKNESS	CCT	CRI	OPTIC	MEDIA 1	MEDIA 2
-0 (5/8" Ceiling Thickness)	27 (2700K)	90 (90 CRI)	-10 (10° Spot)	(blank) (None)	(blank) (None)
-1 (1 1/4" Ceiling Thickness)	30 (3000K)		-30 (30° Narrow Flood)	CL (Clear Lens)	CL (Clear Lens)
-2 (2" Ceiling Thickness)	35 (3500K)		-50 (50° Flood)	MP (Solite Lens)	MP (Solite Lens)
	40 (4000K)		-80 (80° Wide Flood)	FR (Frosted Lens)	FR (Frosted Lens)
	WD³ (1800K~3000K)			LS (Linear Spread Lens)	LS (Linear Spread Lens)
			HX¹ (Hex Louver)		
DRIVER ASSEMBLY					
WATTAGE	LED DIMMING DRIVER		HANGER BAR		
-10 (10 Watt)	S⁴ (Universal Dim Driver: 1%-100% 0-10V, TRIAC, ELV, 120V/277V)		-SHB (Standard)		
-15 (15 Watt)	REMOTE LED DIMMING DRIVER		-C24 (24" C-Channel)		
-20² (20 Watt)			-C48 (48" C-Channel)		
	SR1⁴ (Remote Universal Dim: 1%-100% 0-10V, TRIAC, or ELV, 120V/277V)				

1. Cannot be used with a second media. 2. 20 Watt option only available for SNC (Shallow Plenum New Construction) only.
 3. Media 1 lens required. For WD with 10°, 30°, 50° Optic use MP (Solite Lens). For WD with 80° Optic use FR (Frosted Lens). 4. TRIAC, ELV dimming for 120V only.

2" SHALLOW PLENUM NEW CONSTRUCTION TRIM (EXAMPLE: A2-RSTWT-STWT-NL)

TRIM				REFLECTOR		
FAMILY APERTURE	TRIM SHAPE	TRIM STYLE	TRIM FINISH	REFLECTOR STYLE	REFLECTOR FINISH	REFLECTOR LENS
A2- Acrobat 2"	R (Round)	ST (Standard)	TL⁴ (Trimless/Wood Ceiling)	-ST² (Standard)	WT (White)	-NL (No Lens)
		TL (Trimless)	WT (White/)	-PH² (Pinhole)	BK (Black)	-CL (Clear)
	S (Square)	WC (Wood Ceiling)	BK (Black)	-SP² (Slot Pinhole)	CA³ (Clear Alzak)	-MP (Solite)
			CN (Champagne)	-WW (Wall Wash)	CN (Champagne)	-FR (Frosted)
			SA (Satin Aluminum)		SA (Satin Aluminum)	
		CC¹ (Custom Color)		CC¹ (Custom Color)		

1. Custom color only available for ST (Standard) Trim and ST (Standard), AL (Adjustable Lens) Reflectors only, contact CSL for details.
 2. Wet Location rated when used with Additional Reflector Lens.
 3. CA (Clear Alzak) Finish only available for Round reflectors as ST (Standard) or AL (Adjustable Lens) styles. 4. Must be used with TL or WC trim style.

EMERGENCY OPTIONS

EM-1000 (25W Remote Inverter)	EM-1003 (35W Remote Inverter)	EM-1004 (50W Remote Inverter)
EM-1002 (10W Remote Inverter)	EM-1003-CA (35W Remote Inverter) Title 20	EM-1006 (25W Remote Inverter) Title 20



**ACROBAT 2" LED DOWNLIGHT
SHALLOW PLENUM**

PROJECT: _____

TYPE: _____

NOTE: _____

SPEC-00275 ACROBAT 2.0, 2" SP, V-1.3, UPDATED 10/14/2022

A2-SIC, A2-SNC

HOUSING AND LIGHT ENGINE LINE DRAWINGS

A2-SIC, A2-SNC
Shallow Plenum Housing

CEILING THICKNESS

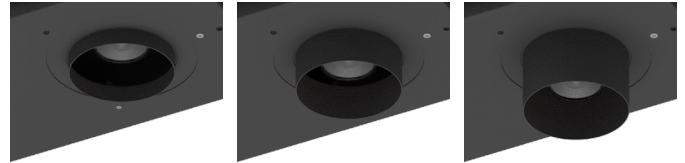

-0

5/8" Ceiling Thickness

-1

1 1/2" Ceiling Thickness

-2

2" Ceiling Thickness

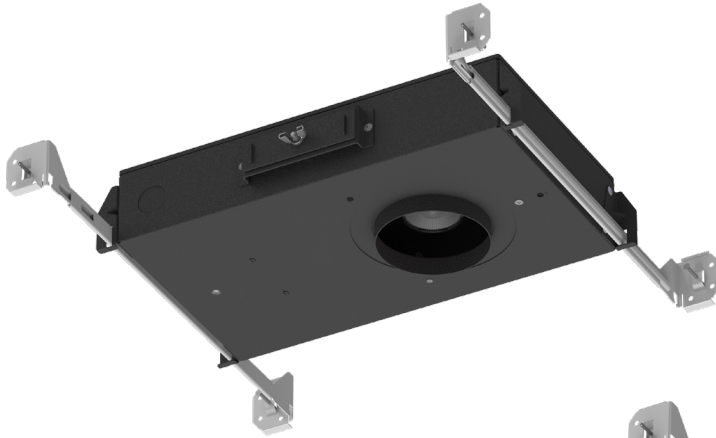

A2-SIC-R

Acrobat 2" - Shallow Plenum New Construction IC Housing - Round

A2-SNC-R

Acrobat 2" - Shallow Plenum New Construction Housing - Round

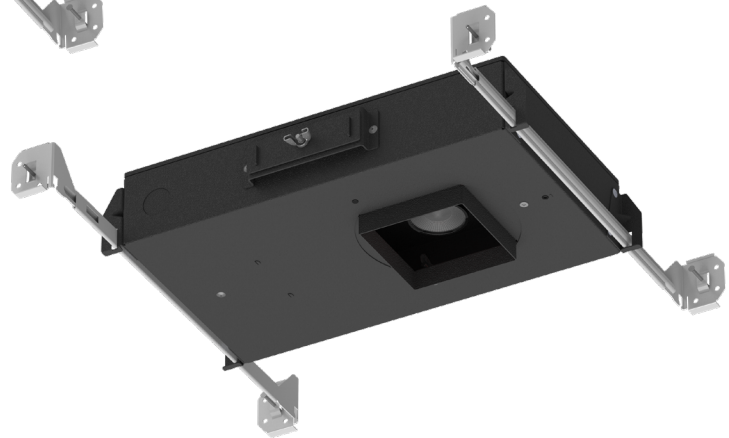

A2-SIC-S

Acrobat 2" - Shallow Plenum New Construction IC Housing - Square

A2-SNC-S

Acrobat 2" - Shallow Plenum New Construction Housing - Square

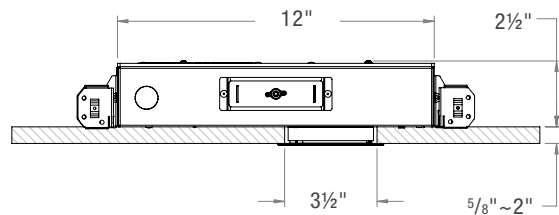
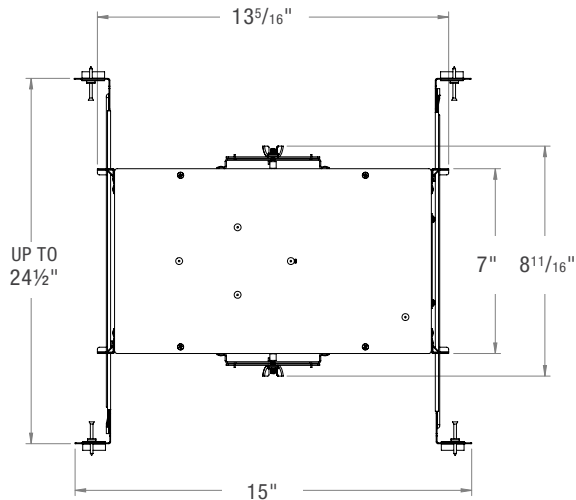

TRIM STYLES

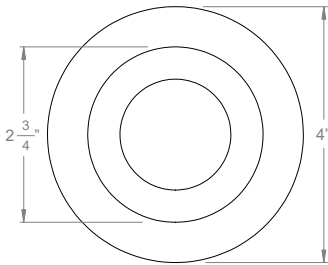
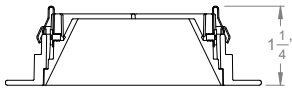
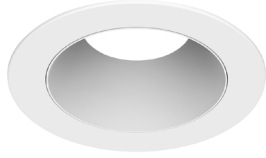

RST

2" Acrobat Round Standard Trim
(with Standard Reflector)

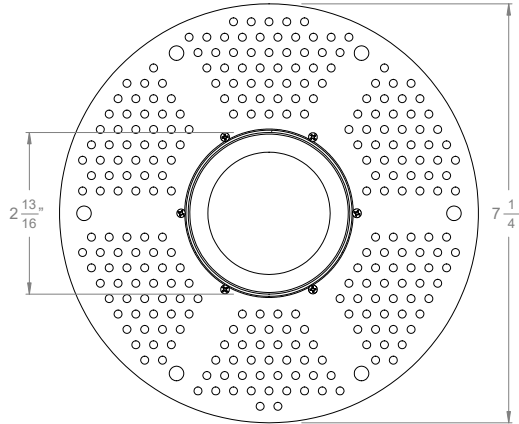
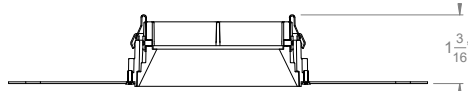
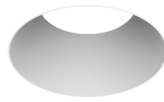

RTL

2" Acrobat Round Trimless Mud Plate
(with Standard Reflector)

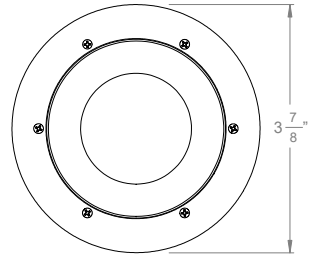
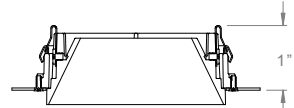

RWC

2" Acrobat Round Wood Ceiling Trim
(with Standard Reflector)

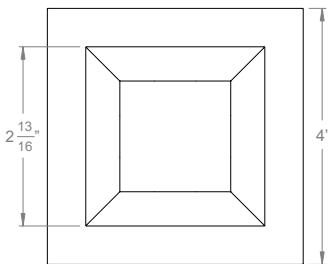
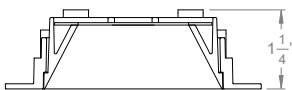
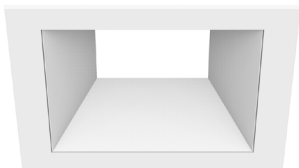

SST

2" Acrobat Square Standard Trim
(with Standard Reflector)

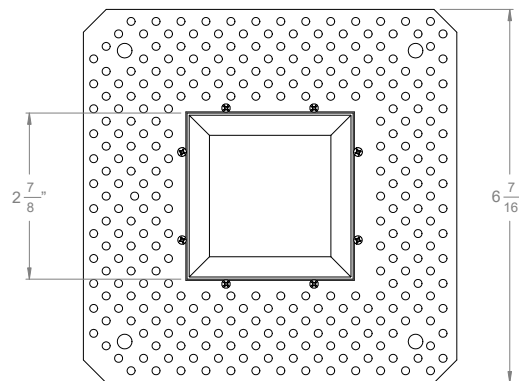
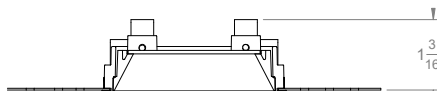
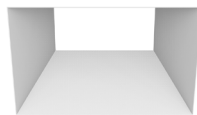

STL

2" Acrobat Square Trimless Mud Plate
(with Standard Reflector)

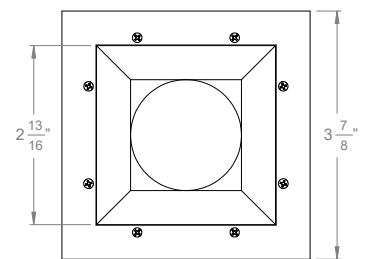
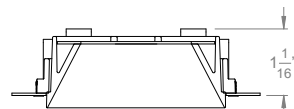
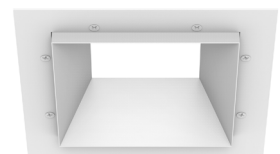

SWC

2" Acrobat Square Wood Ceiling Trim
(with Standard Reflector)

REFLECTOR STYLE (ROUND)

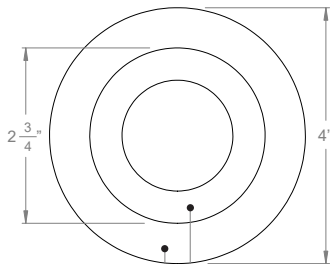
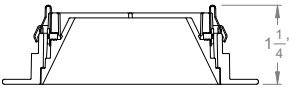
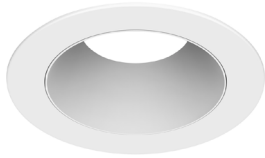

Trim Reflector
RST -ST

2" Acrobat Round Standard Trim
with Standard Reflector

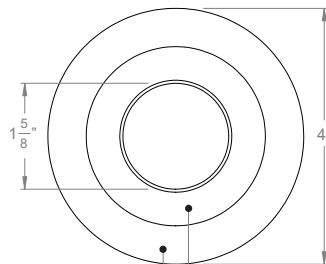
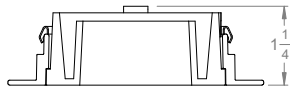
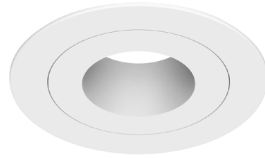

Trim Reflector
RST -PH

2" Acrobat Round Standard Trim
with Pinhole Reflector

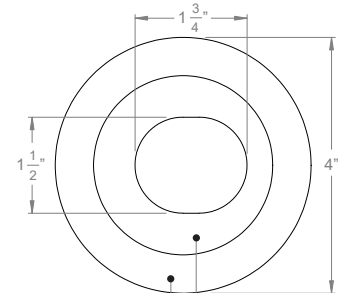
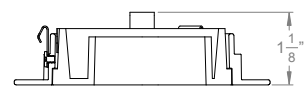
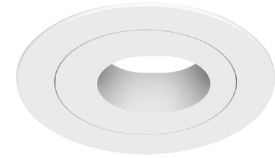

Trim Reflector
RST -SP

2" Acrobat Round Standard Trim
with Slot Pinhole Reflector

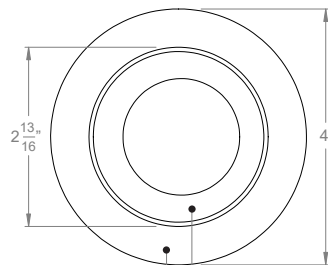
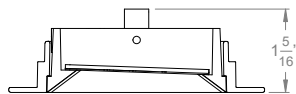

Trim Reflector
RST -WW

2" Acrobat Round Standard Trim
with Wall Wash Reflector

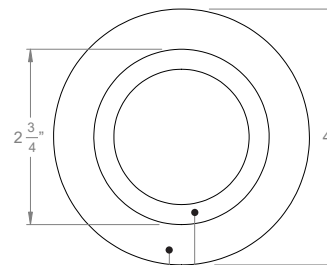
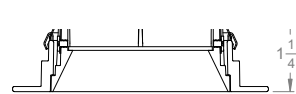
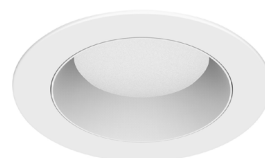

Trim Reflector
RST -AL

2" Acrobat Round Standard Trim
with Adjustable Lensed Reflector

REFLECTOR STYLE (SQUARE)

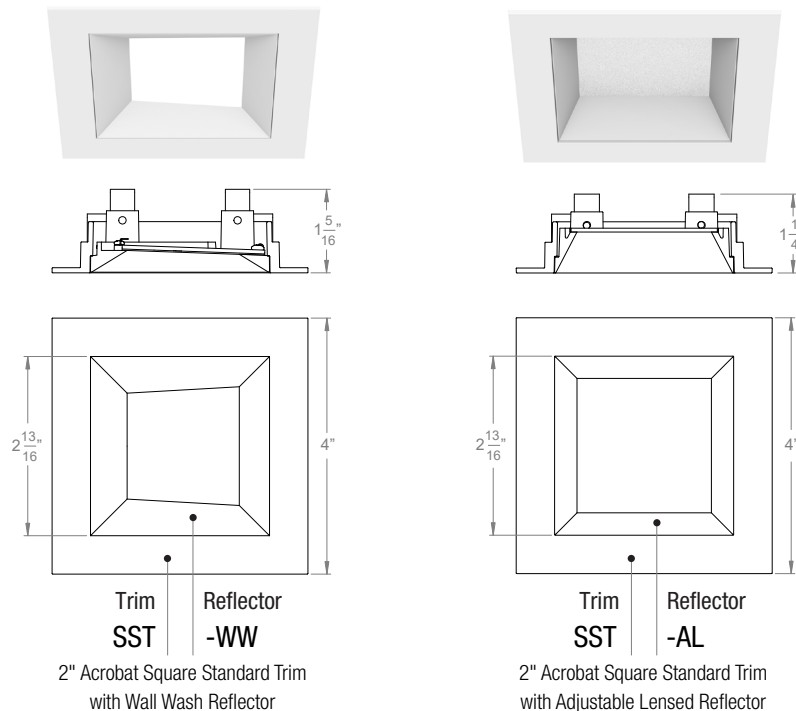
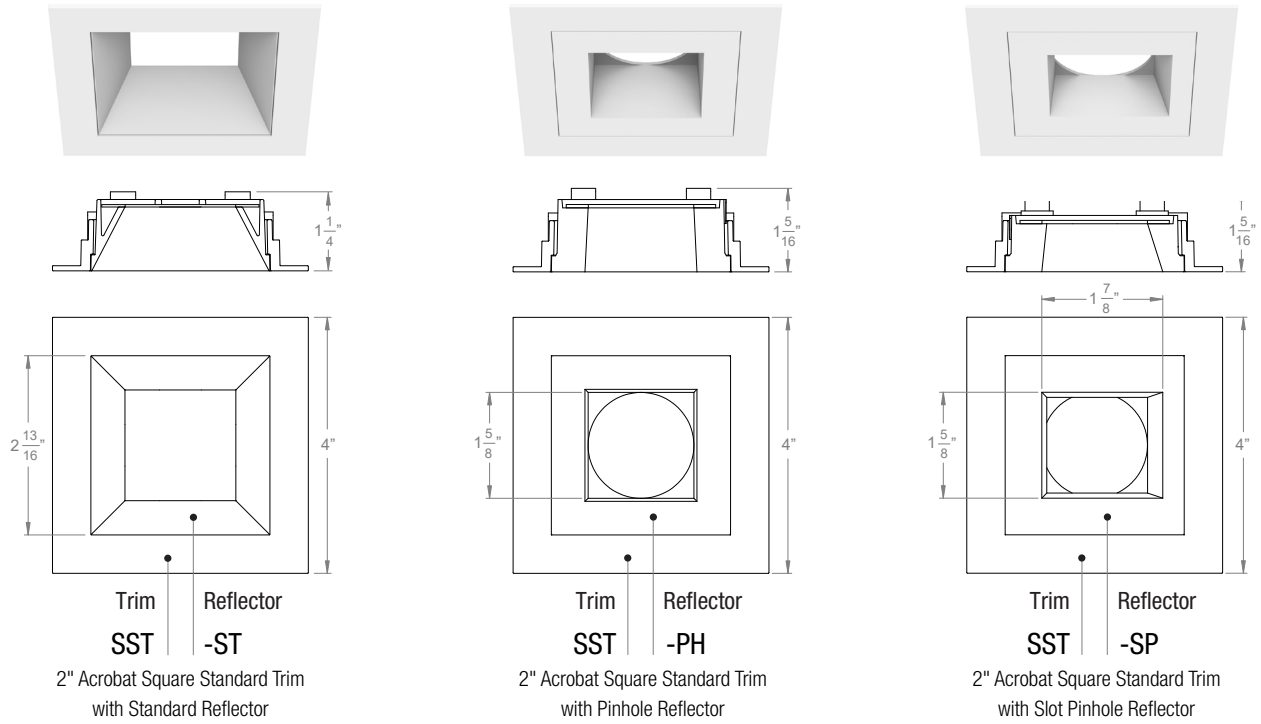



ACROBAT 2" LED DOWNLIGHT SHALLOW PLENUM

PROJECT: _____

TYPE: _____

NOTE: _____

SPEC-00275 ACROBAT 2.0, 2" SP, V-1.3, UPDATED 10/14/2022

A2-SIC, A2-SNC

TRIM FINISHES

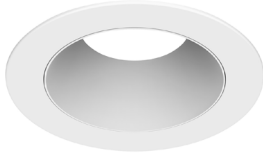

RSTWT-STWT
WT White Trim
WT White Reflector



RSTBK-STBK
BK Black Trim
BK Black Reflector

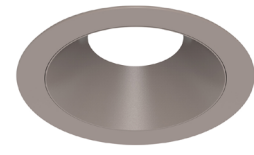

RSTCN-STCN
CN Champagne Trim
CN Champagne Reflector

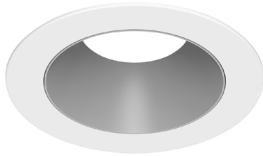

RSTWT-STSA
WT White Trim
SA Silver Reflector

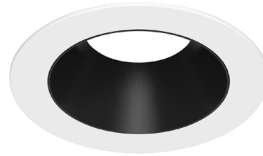

RSTWT-STBK
WT White Trim
BK Black Reflector

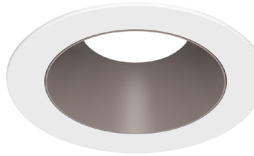

RSTWT-STCN
WT White Trim
CN Champagne Reflector

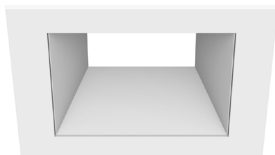

SSTWT-STWT
WT White Trim
WT White Reflector

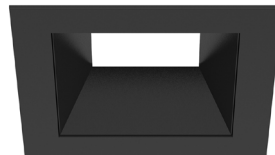

SSTBK-STBK
BK Black Trim
BK Black Reflector

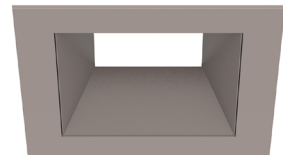

SSTCN-STCN
CN Champagne Trim
CN Champagne Reflector

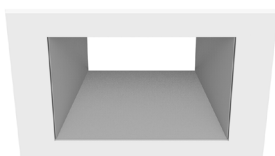

SSTWT-STSA
WT White Trim
SA Silver Reflector

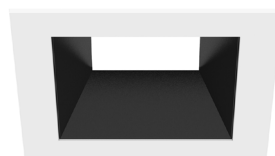

SSTWT-STBK
WT White Trim
BK Black Reflector

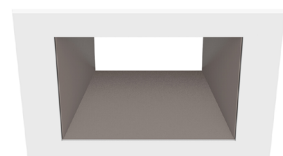

SSTWT-STCN
WT White Trim
CN Champagne Reflector

DIMMING DRIVER COMPATIBILITY

DIMMER LIST

"S" ERP PHASE-CUT DIMMERS			
Dimmer Information			
Manufacturer	Product	Manufacturer	Product
Cooper	DAL06P	Lightolier	ZP260QEW
	DLC03P	Lutron	CT103P
	SLC03P		DV600P
Leviton	6161		DVCL-153P
	6631-2		DVELV303P
	6633-P		FAELV500
	6673-10W		LG600P
	6683-IW		MAELV600
	IPE04		S600P
	IPI06-1LZ		S-603PG
	VPE06		SELV300P
			TG-600P
			TGCL-153P

NOTES:

Wiring diagrams are examples of typical installations intended to illustrate the number of wires that must be run to fixture. These diagrams are not intended to specify all equipment necessary for a given dimming circuit. Refer to specific dimmer manufacturer's documentation for details.

**S- ERP DRIVER
2 WIRE PHASE DIMMING**

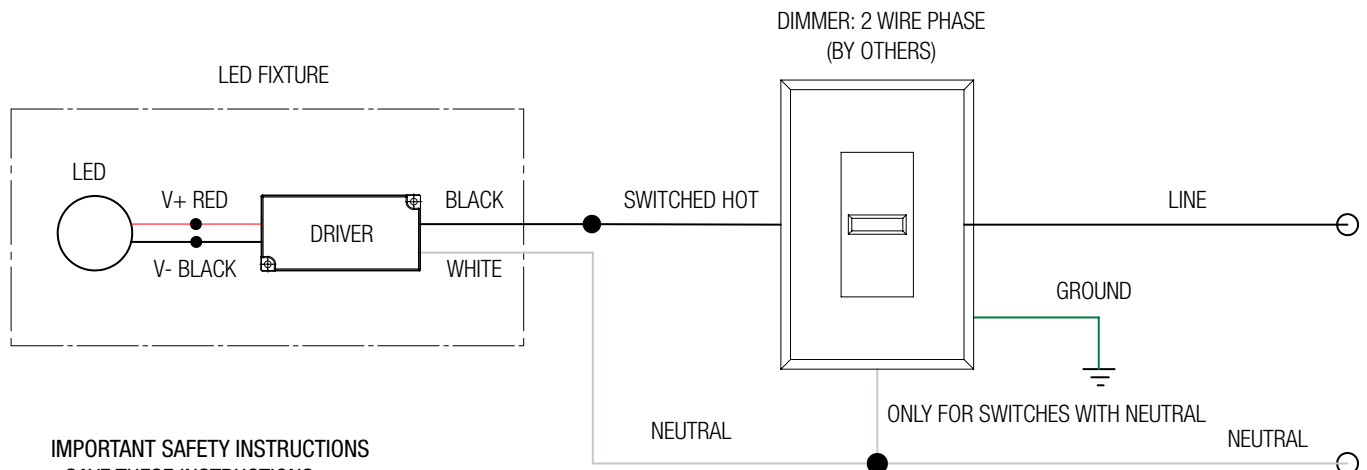

**IMPORTANT SAFETY INSTRUCTIONS
- SAVE THESE INSTRUCTIONS**

1. Keep these instructions in a safe place for future reference.
2. Only qualified electricians in accordance to local codes should install these fixtures.
3. De-energize the electrical circuit at the circuit breaker prior to installation process or servicing.
4. Make sure all connections are in accordance with the National Electrical Code and any local regulations.
5. Cap any wires not used separately (not together).

DIMMING DRIVER COMPATIBILITY

DIMMER LIST

"S" ERP 0-10V	
Dimmer Information	
Manufacturer	Product
Leviton	IP740-DLZ
Lightolier	ZP600FAM120
	V2000FAMU
Lutron	DVTV
	NTFTV
Crestron	CLS-EXP-DIMFLV
	DIN-4DIMFLV4
	DIN-A08
	GLX-DIMFLV8

NOTES:

Wiring diagrams are examples of typical installations intended to illustrate the number of wires that must be run to fixture. These diagrams are not intended to specify all equipment necessary for a given dimming circuit. Refer to specific dimmer manufacturer's documentation for details.

**S- ERP DRIVER
0-10V DIMMING**

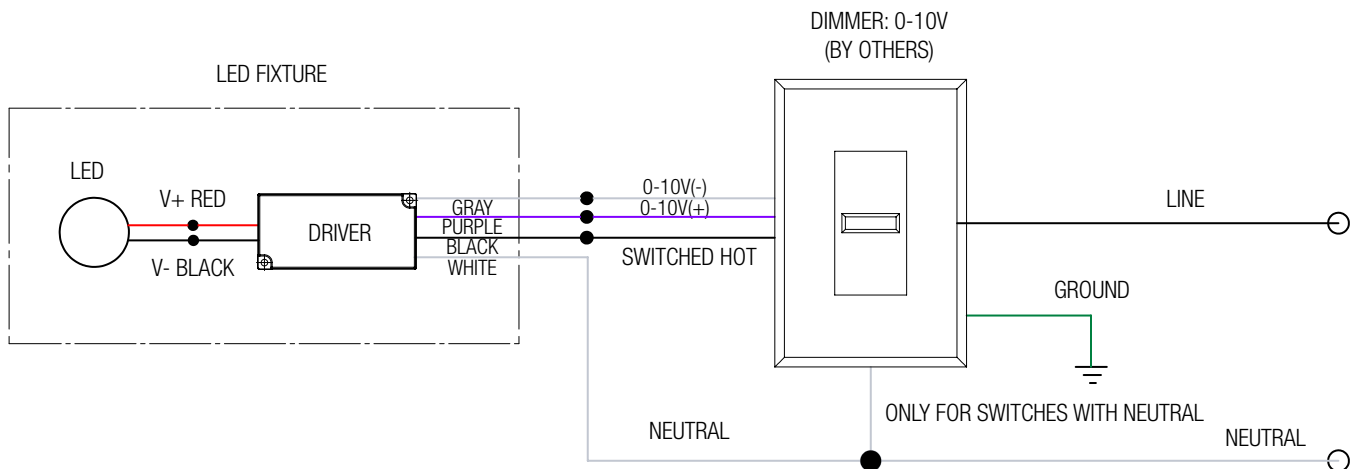

IMPORTANT SAFETY INSTRUCTIONS

- SAVE THESE INSTRUCTIONS

1. Keep these instructions in a safe place for future reference.
2. Only qualified electricians in accordance to local codes should install these fixtures.
3. De-energize the electrical circuit at the circuit breaker prior to installation process or servicing.
4. Make sure all connections are in accordance with the National Electrical Code and any local regulations.
5. Cap any wires not used separately (not together).

DIMMING DRIVER COMPATIBILITY

DIMMER LIST

"L1" Lutron Hi-lume 2-Wire	
Dimmer Information	
Manufacturer	Product
Leviton	IPE04
	IPI06-1LZ
	6633-P
Lutron	DVELV300P
	DVCL-153P
	S600P
Cooper	DAL06P
	DLC03P
	SLC03P

NOTES:

Wiring diagrams are examples of typical installations intended to illustrate the number of wires that must be run to fixture. These diagrams are not intended to specify all equipment necessary for a given dimming circuit. Refer to specific dimmer manufacturer's documentation for details.

**L1- LUTRON DRIVER
2-WIRE DIMMING**

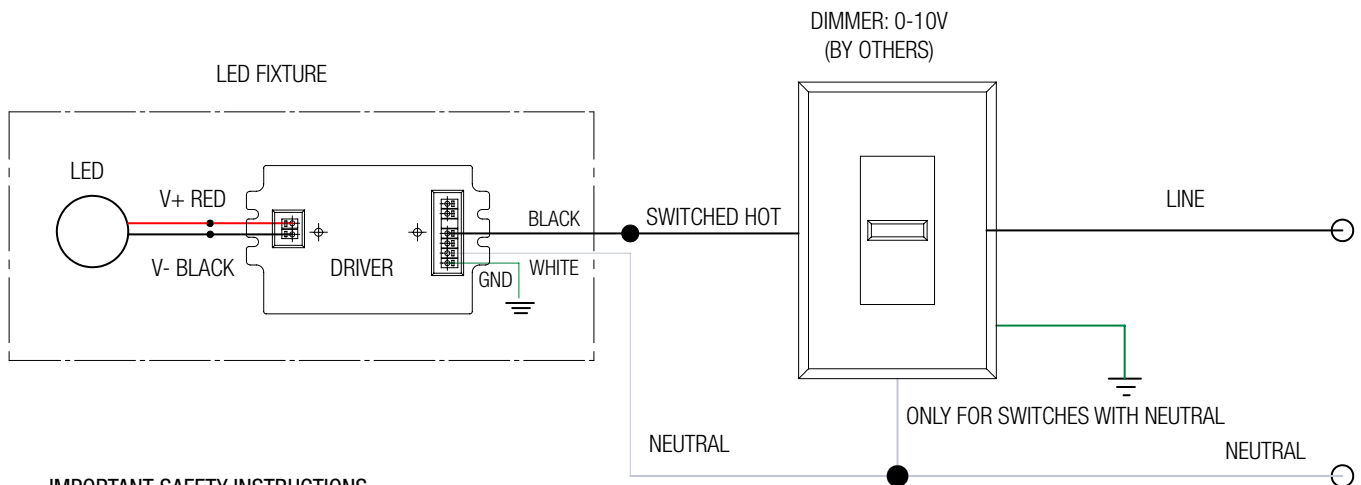

IMPORTANT SAFETY INSTRUCTIONS

- SAVE THESE INSTRUCTIONS

1. Keep these instructions in a safe place for future reference.
2. Only qualified electricians in accordance to local codes should install these fixtures.
3. De-energize the electrical circuit at the circuit breaker prior to installation process or servicing.
4. Make sure all connections are in accordance with the National Electrical Code and any local regulations.
5. Cap any wires not used separately (not together).